

# Afmetingen/dimensions View 2

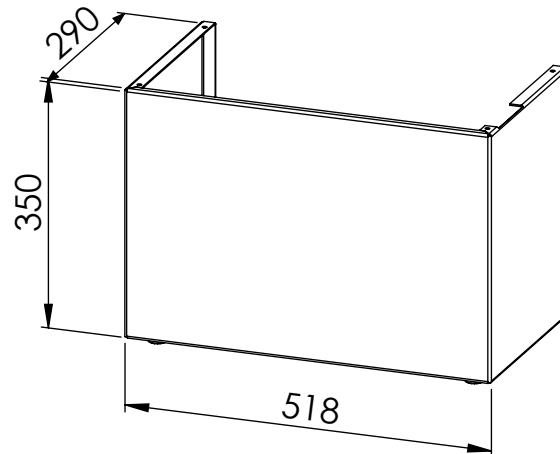

Voet optioneel  
Pied optionnel

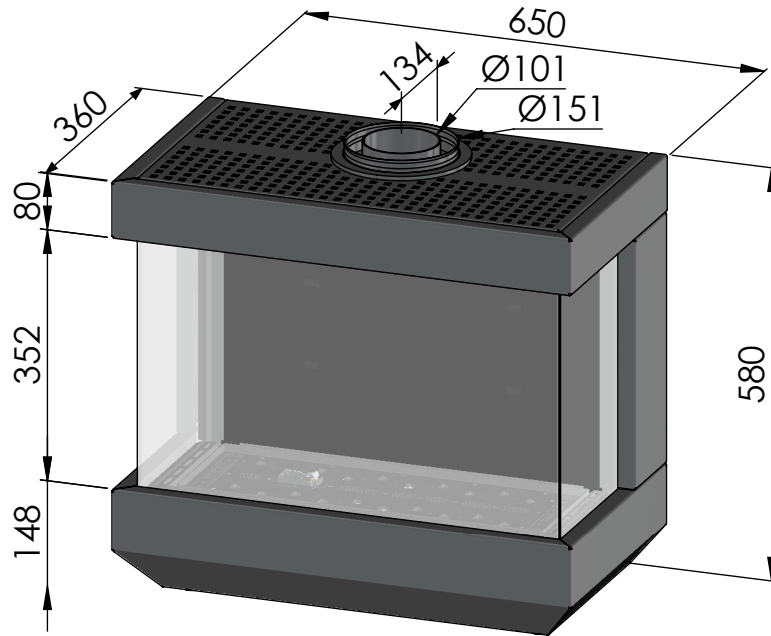